



MICHIGAN OHIO UNIVERSITY TRANSPORTATION CENTER  
*Alternate energy and system mobility to stimulate economic development.*

---

Report No: MIOH UTC TS21p1 2010-Final



**MANAGEMENT AND ANALYSIS OF  
MICHIGAN INTELLIGENT TRANSPORTATION SYSTEMS  
CENTER DATA WITH APPLICATION TO THE  
DETROIT AREA I-75 CORRIDOR**

**FINAL REPORT**

**PROJECT TEAM**

**Dr. Charles Standridge  
Dr. Shabbir Choudhuri  
School of Engineering**

**Dr. David Zeitler  
Department of Statistics**

**Grand Valley State University  
301 West Fulton  
Grand Rapids, MI 49504**

**With Contributions By  
Dr. Snehamay Khasnabis  
College of Engineering  
Wayne State University  
2168 Engineering Building  
Detroit, MI 48202**

Report No: MIOH UTC TS21p1 2010-Final

TS 21, Series, Project 1, September 2008 through August 2009  
FINAL REPORT

**Developed By:**

**Charles R. Standridge**  
Principal Investigator, GVSU  
[standric@gvsu.edu](mailto:standric@gvsu.edu)  
616-331-6750

**Shabbir Choudhuri**  
Investigator, GVSU  
[choudhus@gvsu.edu](mailto:choudhus@gvsu.edu)

**David Zeitler**  
Investigator, GVSU  
[zeitlerd@gvsu.edu](mailto:zeitlerd@gvsu.edu)

**With Contributions By:**

**Snehamay Khasnabis**  
Co-Principal Investigator, WSU  
[skhas@wayne.edu](mailto:skhas@wayne.edu)

**SPONSORS**

This is a Michigan Ohio University Transportation Center project funded by the U.S. Department of Transportation, the Michigan Department of Transportation, Grand Valley State University, and Wayne State University.

**ACKNOWLEDGEMENT**

In addition to the Sponsors, the Project Team would like to acknowledge support from the Michigan Intelligent Transportation Systems Center (MITSC), and the Southeastern Michigan Council of Governments (SEMCOG) during the course of this research. This support is gratefully acknowledged.

**DISCLAIMERS**

The contents of this report reflect the views of the authors, who are responsible for the facts and the accuracy of the information presented herein. This document is disseminated under the sponsorship of the Department of Transportation University Transportation Centers Program, in the interest of information exchange. The U.S. Government assumes no liability for the contents or use thereof.

The opinions, findings and conclusions expressed in this publication are those of the authors and not necessarily those of the Michigan State Transportation Commission, the Michigan Department of Transportation, or the Federal Highway Administration.

## **Abstract**

An understanding of traffic flow in time and space is fundamental to the development of strategies for the efficient use of the existing transportation infrastructure in large metropolitan areas. Thus, this project involved developing the methods necessary to systematically describe, explain, and predict the flow of traffic with respect to time and space. The utility of this knowledge was demonstrated in routing voluminous traffic. Achieving these objectives required the collection, management, and analysis of traffic data concerning volume, speed, and traffic sensor occupancy. Management of this data required the design and implementation of a large scale database management system as well as assuring the quality of the collected data. Descriptive, explanatory, and predictive statistical models were developed to help gain the desired understanding of traffic flow. Application efforts focused on the Detroit metropolitan area. Traffic data was regularly obtained from the Michigan Intelligent Transportation Systems Center. Statistical models of traffic flow in the Detroit area I-75 corridor were constructed. A previously developed routing model was extended and adapted to the I-75 corridor and the newly developed statistical models incorporated to help compute traffic flow metrics. Both a software solver and a hardware solver for the model were implemented. In addition, a framework for traffic simulation was developed and applied to the development and calibration of a micro-simulation model including the same part of the I-75 corridor. This model was used to demonstrate the benefits of guidance in re-routing traffic as a result of a traffic incident.

## Table of Contents

1. Executive Summary.....	1
2. Action Plan for Research.....	2
3. Introduction.....	3
4. Objective.....	5
5. Scope.....	5
6. Methodology.....	7
6.1. <i>Statistical Analysis</i> .....	7
6.2. <i>Re-Routing Models</i> .....	8
6.3. <i>Micro-Simulation for Incident Management Assessment Strategies</i> .....	9
7. Discussion of Results.....	10
7.1. <i>Statistical Analysis</i> .....	10
7.2. <i>Re-Routing Models</i> .....	12
7.3. <i>Micro-Simulation for Incident Management Assessment Strategies</i> .....	13
8. Conclusion.....	17
8.1. <i>Statistical Analysis</i> .....	17
8.2. <i>Re-Routing Models</i> .....	17
8.3. <i>Micro-Simulation for Incident Management Assessment Strategies</i> .....	17
9. Recommendations for Future Research.....	17
9.1. <i>Statistical Analysis</i> .....	17
9.2. <i>Re-Routing Models</i> .....	17
9.3. <i>Micro-Simulation for Incident Management Assessment Strategies</i> .....	17
10. Recommendations for Implementation.....	18
10.1. <i>Statistical Analysis</i> .....	18
10.2. <i>Re-Routing Models</i> .....	18
10.3. <i>Micro-Simulation for Incident Management Assessment Strategies</i> .....	18
11. List of Acronyms, Abbreviations, and Symbols.....	19
12. Bibliography.....	20

## List of Tables

Table 1.	Student Participation.....	4
Table 2.	Location of the Sensors for Statistical Analysis .....	5
Table 3.	Measures of Calibration.....	9
Table 4.	Summary of Calibration Test Results – Traffic Volume.....	16
Table 5.	Summary of Calibration Test Results – Travel Time.....	16

## List of Figures

Figure 1.	Project Organization .....	3
Figure 2.	Northern Portion of I-75 Corridor in Detroit.....	6
Figure 3.	Previous Re-routing Model.....	8
Figure 4.	Speed and Occupancy for One Day for the Sensor 68865 .....	10
Figure 5.	Regression Equations for Coefficients .....	11
Figure 6.	Prediction Error for One-Minute Time Interval .....	11
Figure 7.	Prediction Error for 30-Minute Time Interval .....	12
Figure 8.	Electrical Schematic Representation of the Traffic Corridor of Figure 2 .....	13
Figure 9.	No Incident Scenario -- Sensor: MI075200N (I-75 South of 12 Mile Road), Date: 7/12/2008, Time: 3:00 - 6:00 P.M.....	14
Figure 10.	No Incident Scenario Date: 7/12/2008, Time: 3:00 - 4:00 P.M.....	14
Figure 11.	Incident Scenario: Abandoned Vehicle Right Lane Closure: SB I-75 @ 12 Mile Road. Sensor: MI075180S (I-75 South of 14 Mile Road), Date: 1/19/2009, Time: 8:35 - 10:00 A.M. ....	15
Figure 12.	Incident Scenario: Abandoned Vehicle Right Lane Closure: SB I-75 @ 12 Mile Rd. ....	15

## **1. Executive Summary**

As investment in construction and expansion decreases, making better use of urban traffic infrastructure is essential. One important aspect of doing so is developing an understanding of the movement of traffic in time and space, including how to re-route large volumes of traffic in case of an incident. Meeting this need requires developing traffic data analysis methods, dynamic re-routing models, and simulation-based incident management system assessment tools. The development of such tools was the focus of this project. In addition, validation of the tools was performed through their application to I-75 corridor in Detroit. The project team consisted of faculty and students from Grand Valley State University and Wayne State University supported by staff from the Michigan Department of Transportation and the Southeast Michigan Council of Governments. The project was divided into three components, each of which will be discussed in turn.

Statistical analysis of intelligent transportation systems data, in particular the data from the Michigan Intelligent Transportation Systems Center, was one project component. Data from one 12-month period was graphed. By examination of the graphs, it was determined that non-holiday weekday data was homogeneous and of the most interest. A multi-level regression model was employed to predict traffic speed update to 30 minutes in the future using only the current speed and the speed one minute in the past. The coefficients of the regression were themselves equations whose parameters were estimated by regression as a function of prediction interval. Predicted speeds were compared to actual speeds with the largest median error being 5.4% over the 30-minutes time horizon.

A dynamic re-routing model for large volumes of traffic around one or more freeway incidents was developed and applied. The model was implemented in software using MATLAB. Results showed the proper change in routes as more traffic was re-routed. A prototype hardware solver for the model, an analog computer, was developed as well. This addressed the issue of computational speed of the re-routing algorithm in order to produce routes repeated in near-real time.

A five-step framework for constructing, calibrating, and applying a micro-simulation model to assess incident management strategies has been developed. Calibration was successfully performed in light of no-traffic incidents and selected traffic incidents using both graphs and standard metrics of performance. Application of the modeled showed that incident management strategies improved traffic flow in terms of both volume and speed.

## **2. Action Plan for Research**

The action plan was designed to help the research team meet its fundamental goals of understanding traffic flow in time and space as well as to apply this understanding in routing voluminous traffic. The research team sought to transform the speed, volume, and occupancy data collected by the Michigan Intelligent Transportation Systems Center (MITSC) concerning the interstate system in the Detroit metropolitan area into a highly usable public resource. Meeting this objective involved the following:

1. Systematically acquire the MITSC data, which has been accomplished and is ongoing via FTP twice a month.
2. Design and implement a database management system for this voluminous data, about 50 gigabytes per year within a MySQL database as well as demonstrate this capability for a small, less than 10percent, subset of the data concerning the Detroit area I-75 corridor.
3. Evaluate the quality of the data. This included determining missing data values and evaluating the effectiveness of the traffic sensors in consistently collecting data.
4. Develop and implement procedures for descriptive, explanatory, and predictive statistical model building to represent the movement of traffic in time and space as well as building models.
5. Apply these results to voluminous traffic re-routing in the Detroit area I-75 corridor, thus demonstrating their utility.
  - a. Continue refining routing models that take into account time and space.
  - b. Continue refining both hardware and software based solvers for these models.
  - c. Develop a procedure to assist an intelligent transportation systems (ITS) in finding alternate routes in an efficient manner in response to traffic incidents.
6. Develop a procedure for developing, calibrating, and applying micro-simulation to traffic incident management scenario (IMS) assessment. Apply this procedure to the Detroit area I-75 corridor.

### 3. Introduction

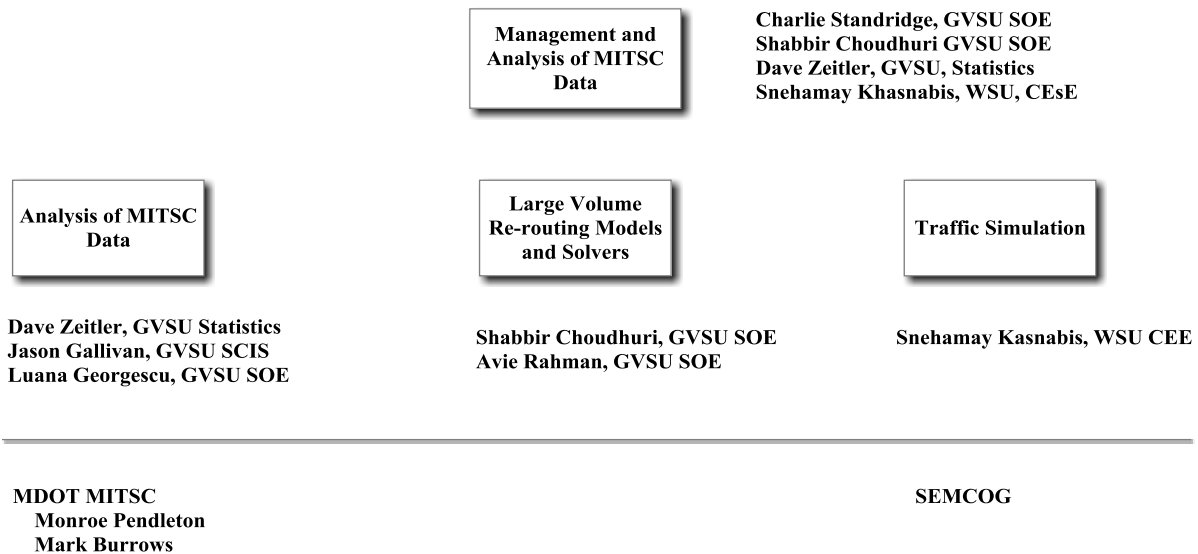
A team of university-based transportation system experts, simulation experts, optimization experts, and applied statisticians has been assembled to develop, implement, and validate an approach to reducing congestion in integrated transportation corridors. This team has been working together since November 2006 with funding provided by the Michigan-Ohio University Transportation Center (MIOH-UTC) through the U.S. Department of Transportation (USDOT) with matching funds supplied by the Michigan Department of Transportation (M-DOT), Grand Valley State University (GVSU), and Wayne State University (WSU). This report covers the period from September 2008 through August 2009.

The team has been working in three areas:

1. Statistical analysis of intelligent transportation systems data, in particular, the data from MITSC.
2. Optimal re-routing of traffic due to traffic incidents on a freeway.
3. Micro-simulation to assess the ability of incident management strategies to effectively re-route traffic around an incident.

As a proof of concept of the procedures and methods we have developed, the above have been applied to a selected portion of the I-75 corridor in Detroit.

The effort has been lead by faculty in the GVSU School of Engineering (SOE) and Department of Statistics as well as the WSU Department of Civil and Environmental Engineering (CEE). The organization of the project is shown in Figure 1.



**Figure 1. Project Organization**

Support for our work has been provided by the Southeastern Michigan Council of Governments (SEMCOG) as well as MDOT, particularly the staff of the MITSC.



Project activities have been supported by graduate assistants and undergraduate students. All students who have participated in this project and related research are listed in Table 1.

**Table 1. Student Participation**

<b>Student</b>	<b>Faculty Mentor</b>	<b>Department</b>	<b>Degree Program</b>	<b>Status on Project</b>	<b>When on Project</b>
Vishnu Yada	Shabbir Choudhuri	GVSU, Computer Information Systems	Master of Science	20 hours weekly, Graduate Assistant	January – December 2007
Ashfaq Rahman	Shabbir Choudhuri	GVSU, School of Engineering	Master of Science	20 hours weekly, Graduate Assistant	August 2007 – present
Andrew Even	Shabbir Choudhuri	GVSU, School of Engineering	Master of Science in Engineering	Capstone project, unpaid	January – December 2007
S. Mishra	Snehamay Khasnabis	WSU, Civil & Environmental Engineering	Ph.D.	Hourly, Graduate Assistant	January 2007 – August 2009
A. Manori	Snehamay Khasnabis	WSU, Civil & Environmental Engineering	Master of Science	Hourly, Graduate Assistant	September 2007-December 2007
S. Swain	Snehamay Khasnabis	WSU, Civil & Environmental Engineering	Master of Science	Hourly, Graduate Assistant	February 2008-August 2010
E. Elibe	Snehamay Khasnabis	WSU, Civil & Environmental Engineering	Master of Science	Hourly, Graduate Assistant	September 2008 – August 2010
S. Vuyyura	Snehamay Khasnabis	WSU, Civil & Environmental Engineering	Master of Science	Hourly, Graduate Assistant	September 2008 – August 2010
Jason Gallivan	Charlie Standridge	GVSU, Computer Information Systems	Master of Science	20 hours weekly, Graduate Assistant	January 2007 – present
Andrew Van Garderen	Dave Zeitler	GVSU, Statistics Department	Bachelor of Science	Semester stipend	August 2007 – May 2008
Allison Wehr	Dave Zeitler	GVSU, Statistics Department	Bachelor of Science	Semester stipend	January – May 2008
Ryan Masselink	Dave Zeitler	GVSU, School of Engineering	Bachelor of Science in Engineering	Semester stipend	May 2009 – April 2010

## 4. Objective

The team has established that its primary research objectives are:

- *To describe, explain, and predict the flow of traffic in a corridor with respect to time and space.*
- *To apply these results in the routing of voluminous traffic.*

The team has addressed the former through the statistical analysis of traffic data obtained from MITSC. Achieving the latter has to do with developing re-routing models for voluminous traffic in response to traffic incidents, particularly on freeways, as well as assessing IMS using micro-simulation.

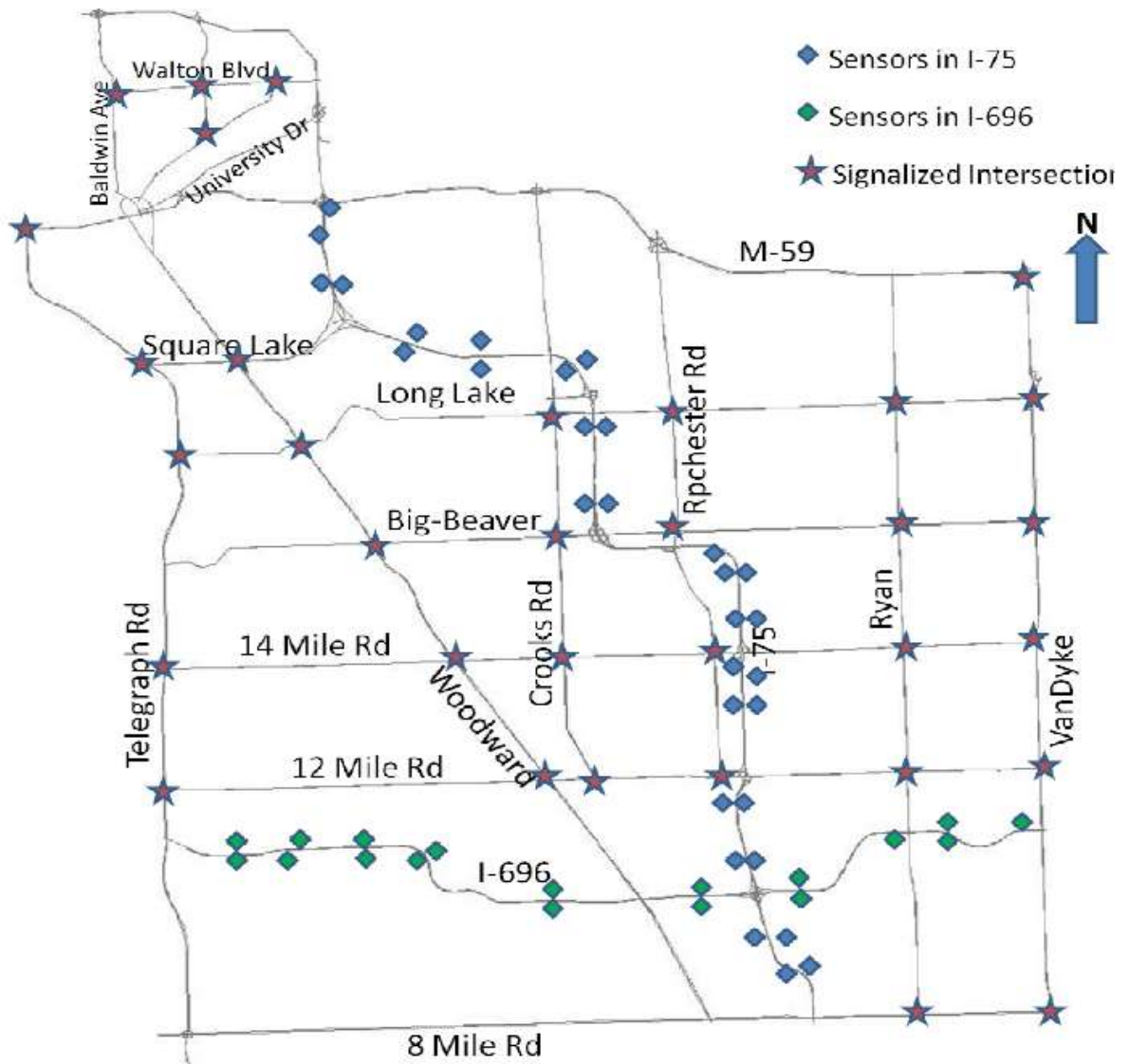
## 5. Scope

In pursuit of its objectives, the team has developed methods in the statistical analysis of traffic data, optimization modeling of voluminous traffic re-routing, and micro-simulation analysis of traffic IMS. Proof of concept for these methods has been accomplished by applying them to the I-75 traffic corridor in Detroit, specifically southbound I-75 between 8 Mile Road on the north and Clay on the south for statistical analysis as shown in Table 2, as well as Baldwin Avenue on the north and 8 Mile Road on the south, as shown in Figure 2, for optimization modeling and micro-simulation.

**Table 2. Location of the Sensors for Statistical Analysis**

Location	Sensor ID	Latitude	Longitude
SB I-75 S of 8 Mile Road	68865	42.44226000000	-83.09524000000
SB I-75 S of 8 Mile Road	68612	42.43976105390	-83.09518743310
SB I-75 S of 7 Mile Road	68353	42.43219393	-83.09489812000
SB I-75 S of Mc Nichols (6 Mile) Road	67841	42.41632659650	-83.08648851500
SB I-75 S of Davison	67333	42.40634558200	-83.07608999730
SB I-75 S of Holbrook	66561	42.38444669210	-83.06696384570
SB I-75 S of Clay	66305	42.37999518890	-83.06403518030

Traffic data of interest was from the period November 2006 through August 2009. Sub-periods were selected in which to demonstrate each method.



**Figure 2. Northern Portion of I-75 Corridor in Detroit**

## 6. Methodology

### 6.1. Statistical Analysis

The statistical analysis of the MITSC data was done in two stages. In the first stage, the data was examined and graphed. Upon examination of the data, it became apparent that some of the sensors transmit erroneous data that is not useful. Only about seven of them, those listed in Table 2 above, transmitted data that could be used in statistical analysis.

The traffic data was graphed for each day of the year for each sensor. Data from November 2006 through October 2007 was employed. It was clear from these graphs that weekday traffic patterns were different from weekend patterns and holidays. No differences were noted among the days of the week or the months of the year. Thus, the second stage statistical analysis used all non-holiday weekdays.

For each minute, the average across days was computed and subtracted from each day's observed value. The statistical analysis of these residuals proceeded as follows. An explanatory / predictive multi-level model (MLM) for traffic speed was developed using regression. The variance in the residuals can be explained based on the current speed and the speed at one time unit previous, in other words by the current speed and the acceleration. The intercept,  $b_{0n}$ , is the average of the residuals which must be 0.

$$S_{t+n} = \underbrace{\bar{S}_{t+n}}_{\text{1st level of MLM}} + \underbrace{b_{0n} + b_{1n} * r_{st} + b_{2n} * r_{st-1}}_{\text{2nd level of MLM}}$$

$n$  is prediction horizon

$S_{t+n}$  is the future speed at time  $t+n$

$\bar{S}_{t+n}$  are the means for every minute calculated at  $t+n$

$r_{st}$  are the residuals of the speed calculated at the current time  $t$

$r_{st-1}$  are the residuals of the speed calculated at the past time  $t-1$

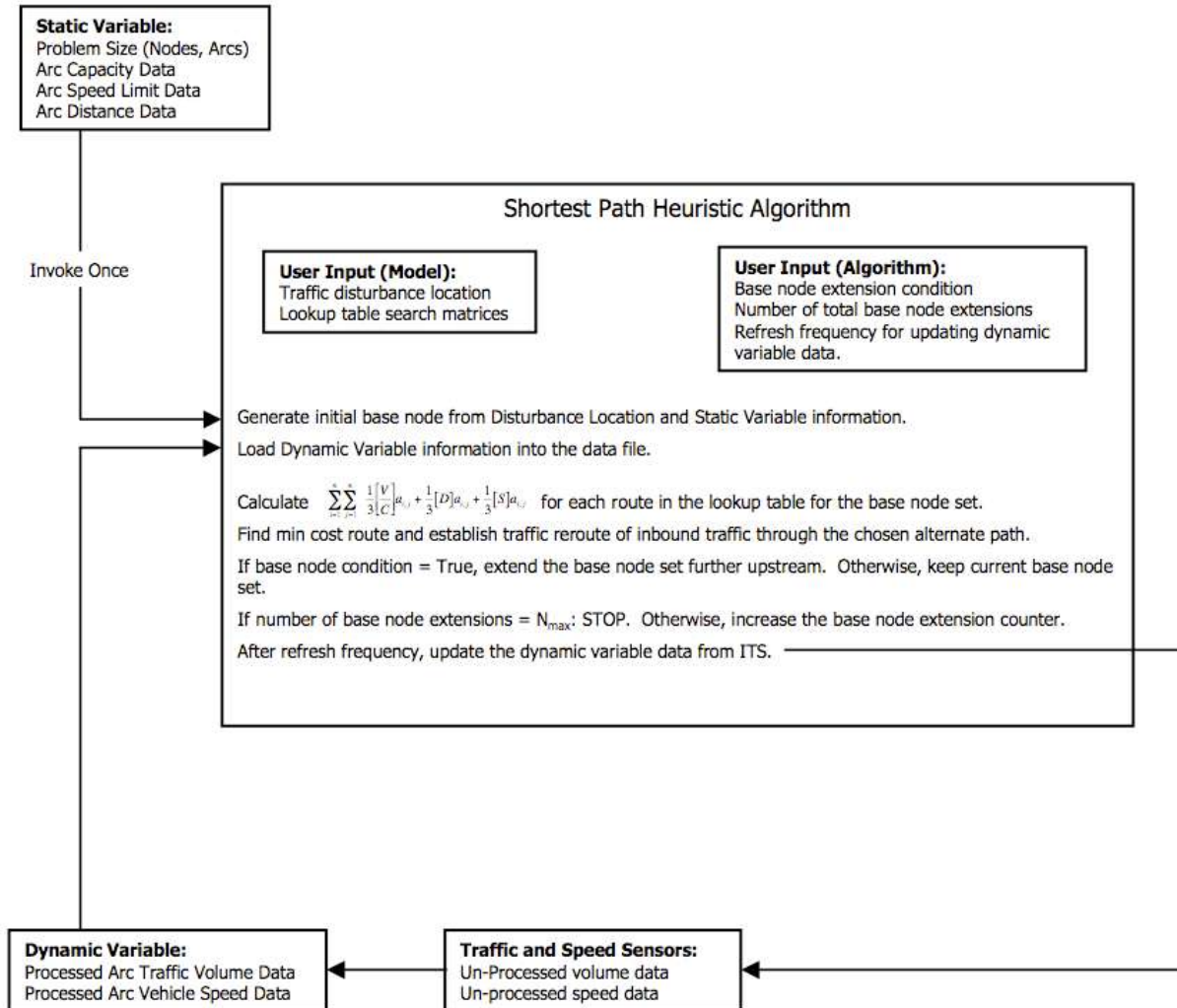
$b_{0n}$  is the constant term or the intercept

$b_{1n}$ , and  $b_{2n}$  are regression coefficients

The coefficients  $b_{1n}$  and  $b_{2n}$  are themselves estimated by regression equations, thus the MLM. The prediction horizon  $n$  ranged from 1 to 30 minutes with intervals 1, 2,..., 10, 15, and 30 minutes used to estimate the parameters of the regression equations of the coefficients in the above equation.

## 6.2. Re-Routing Models

The re-routing model previously developed was extended and tailored to the traffic corridor shown in Figure 2. This previous model is shown in Figure 3.



**Figure 3. Previous Re-Routing Model**

The revised model is called DETSIM and has the following features:

- Graphical Road Network Editor
- Graphical output
- Interactive selection of one or more incidence locations
- Partial closure of a freeway segment
- Usage of standard data interchange format
- A simple simulator of traffic flow
- An improved solver written in MATLAB

The size of the traffic network in Figure 2 raised the issue of whether a software model solver could always compute re-routing information in near real-time. Thus, a hardware implementation was proposed. An electrical network has stark similarities with a traffic network. If the traffic flow of arc can be modeled as a resistor in the electrical network, then the electrical system itself becomes an analog of the traffic system. The re-routing solution can be obtained as quickly as electricity will flow through the network.

**6.3. Micro-Simulation for Incident Management Assessment Strategies**

A framework for the assessment of incident management strategies using micro-simulation has been developed. The five-step methodology encompassing policy and operational strategies associated with IMS can be summarized as follows:

1. Network creation and assembling various databases.
2. Identification of the policies and development of algorithm that comprise the IMS.
3. Calibration of the micro-simulation model.
4. Conducting micro-simulation-based experiments, by creating incidents on the network, and by using the databases, algorithm and policies identified in the earlier steps.
5. Analysis of the results.

The experimental design used in testing the framework encompasses two major components: Model Calibration (Step 3) and Model Application (Step 4). Table 3 gives the measures of calibration.

**Table 3. Measures of Calibration**

<b>GOODNESS-OF-FIT MEASURES</b>	<b>DESIRABLE</b>
RMSE (Measures Overall % Error)	Close to 0
Correlation Coefficient: $r$	Close to 1
Theil's Inequality Coefficient: $U_i$ (Disproportionate Weight of Large Errors)	Close to 0
Theil's Component: $U_s$ (Measure of Variance Proportion )	Close to 0
Theil's Component: $U_c$ (Measure of Covariance Proportion)	Close to 1
Theil's Component: $U_m$ (Measure of Bias Proportion)	Close to 0

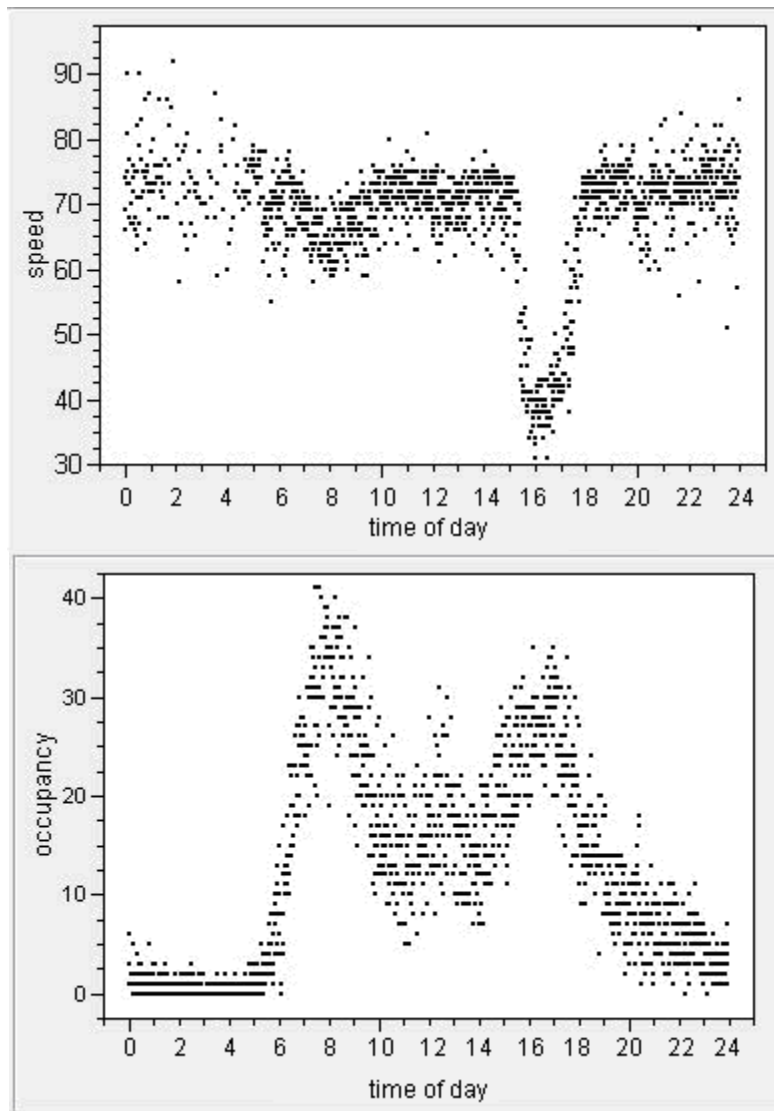
Calibration is done with respect to both traffic volume and traffic speed, both with no traffic incidents and in the presence of traffic incidents.

To test the framework, a model of the traffic network shown in Figure 2 was developed using AIMSUN. Data sources included Traffic.com, MITSC, SEMCOG, and MDOT's Freeway Courtesy Patrol.

## 7. Discussion of Results

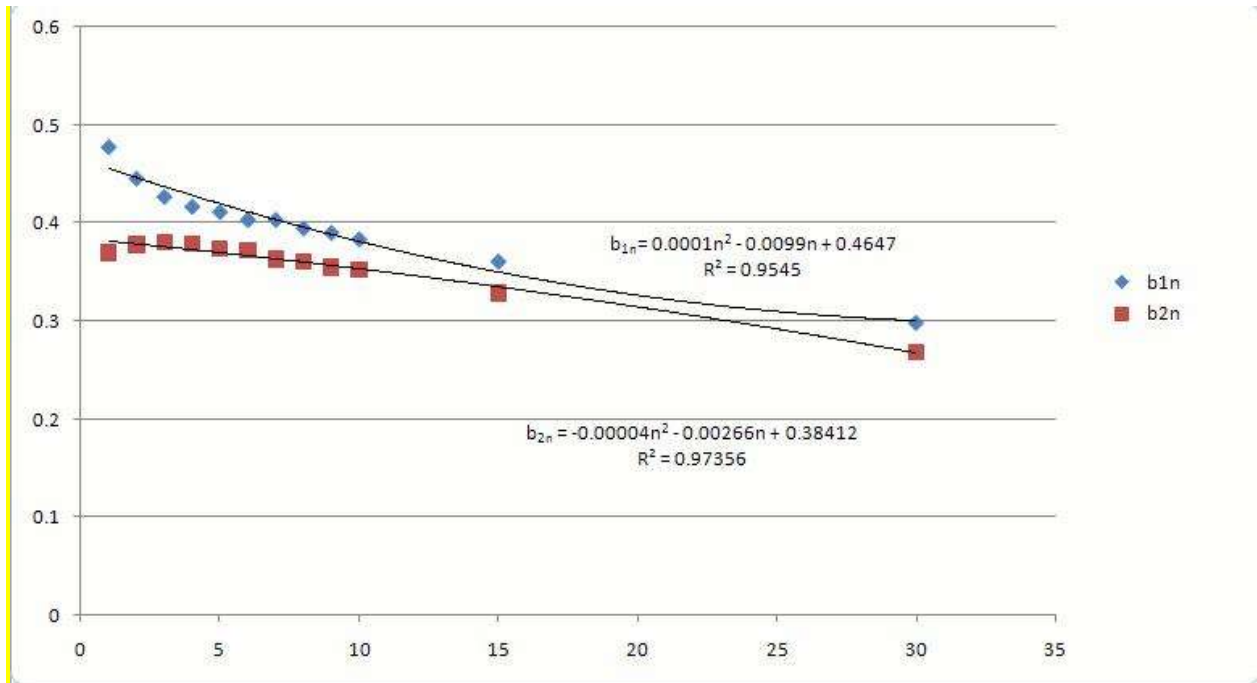
### 7.1. Statistical Analysis

The graphs in Figure 4 show speed and occupancy for one weekday for sensor 68855. Occupancy is increasing between about 6-10am with a minimal speed decrease. Speed is low (about 30 mph) at a congestion point between 3:30-6:00pm.



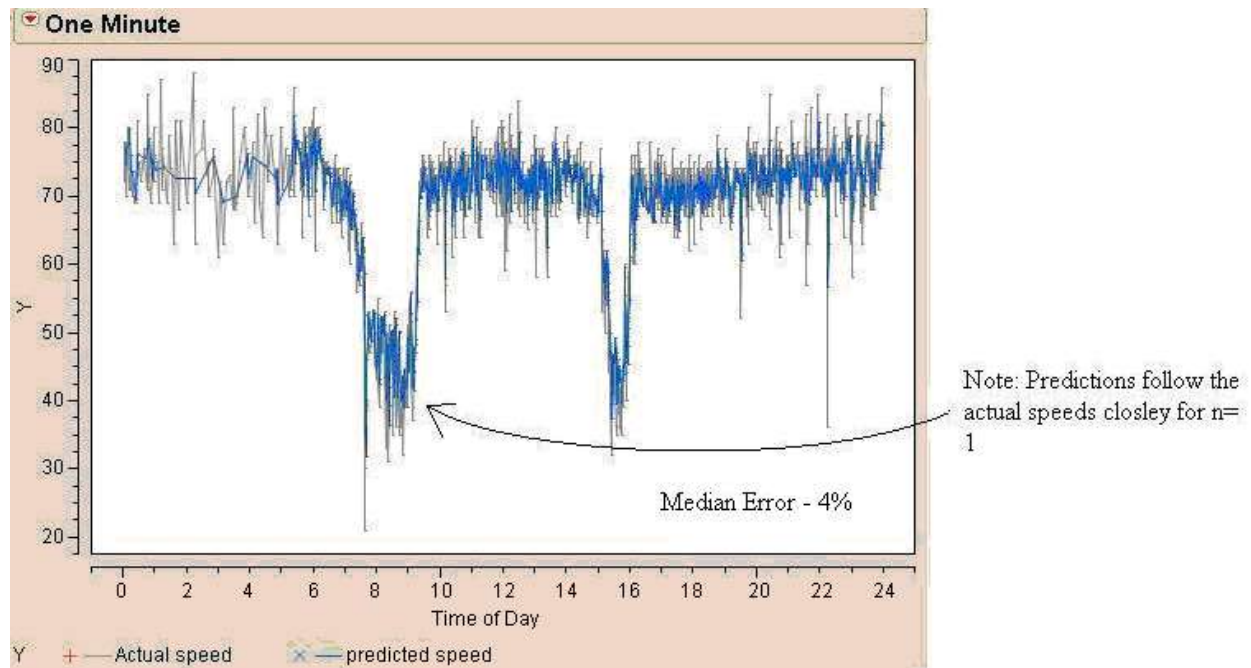
**Figure 4. Speed and Occupancy for One Day for the Sensor 68865**

Figure 5 show the results of estimating the regression coefficients  $b_{1n}$  and  $b_{2n}$  in the MLM.



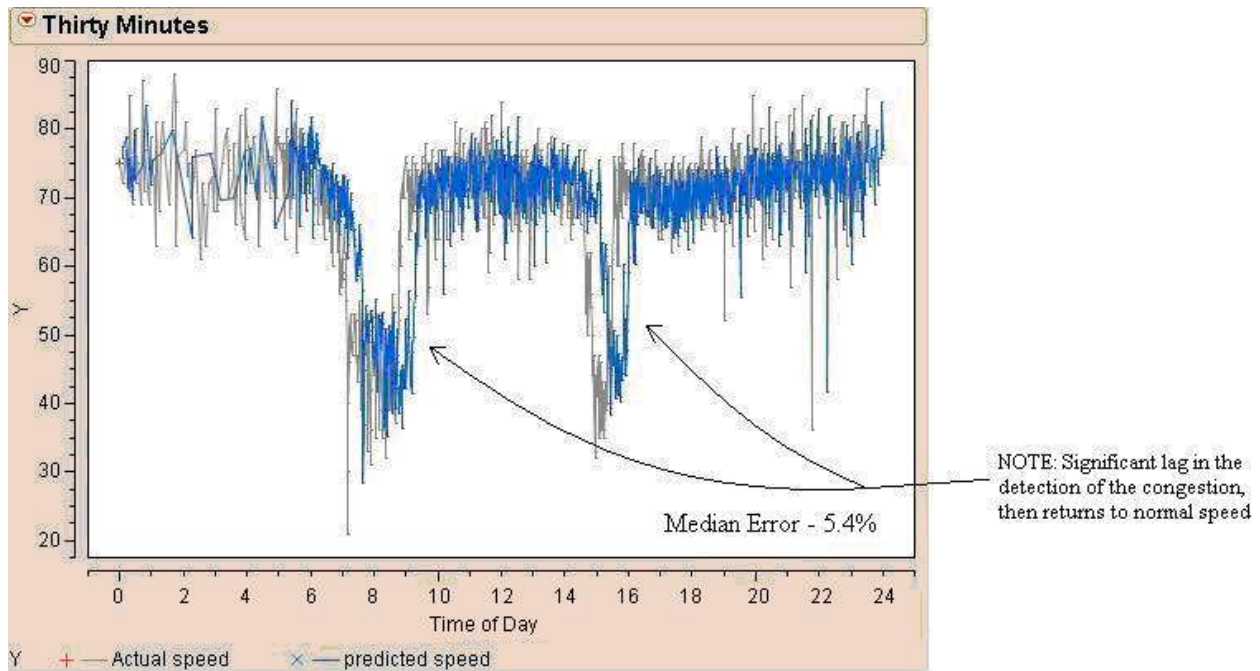
**Figure 5. Regression Equations for Coefficients**

To evaluate the model, predicted speeds were compared with observed speeds. The median error (ME) for the five prediction horizons ranged from 2.6 to 5.4 percent, with smaller percentages associated with smaller prediction horizons. Figures 6 and 7 show the prediction errors for time intervals of one minute and 30 minutes.



**Figure 6. Prediction Error for One-Minute Time Interval**



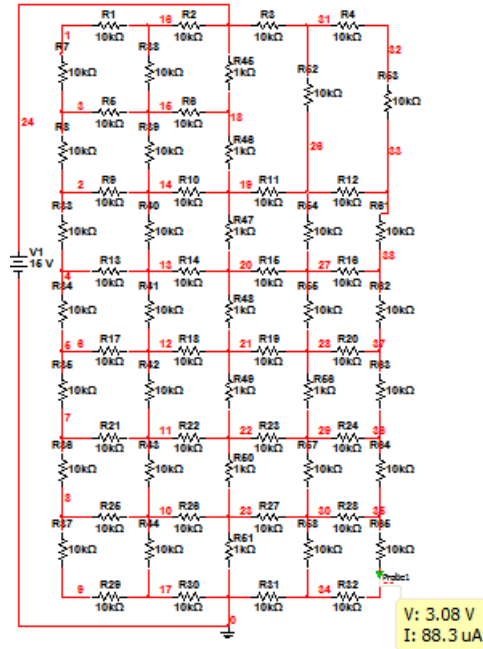


**Figure 7. Prediction Error for 30 Minute Time Interval**

### **7.2. Re-Routing Models**

With respect to the improved software solver, results showed that the best detour path, with respect to avoiding congestion, changes frequently. This was expected as the traffic flow metric on each arc in the traffic network is constantly recomputed, which allows the re-routing to adapt to changes in volume and speed due to previous traffic re-routing.

With respect to the hardware solver, the traffic corridor shown in Figure 2 was implemented as an electric circuit whose schematic is shown in Figure 8. By locating the highest current paths, the best routes with respect to traffic flow can be determined. To measure current, the voltage drop across a fixed value resistor was amplified by an instrumental amplifier, and then sensed by a micro-controller's Analog-to-Digital Converter (ADC). The ADC values were then compared for each segment to find the optimal path.



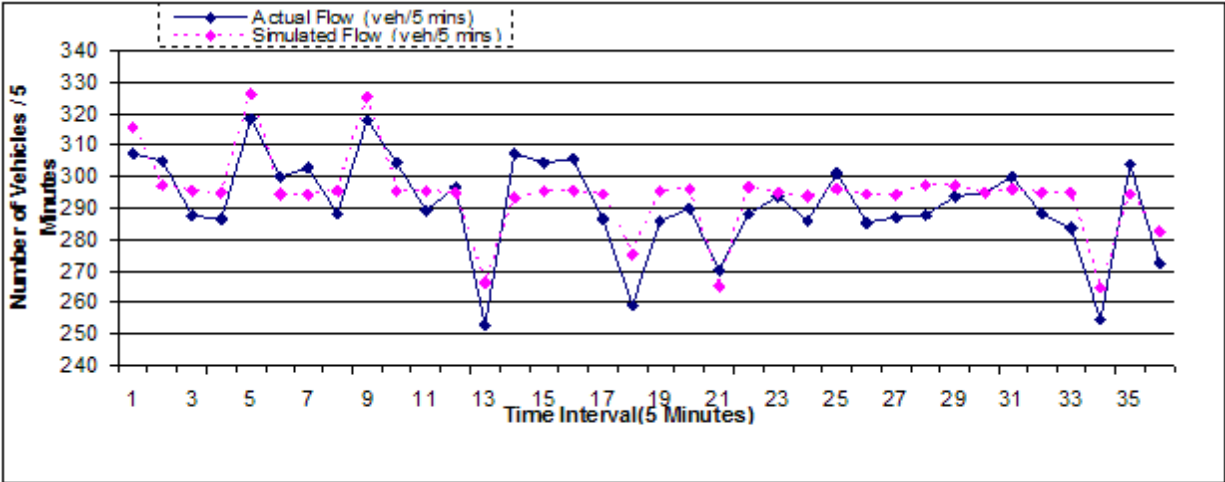
**Figure 8. Electrical Schematic Representation of the Traffic Corridor of Figure 2**

### 7.3. Micro-Simulation for Incident Management Assessment Strategies

The model was first calibrated with no incidents considered. Traffic volume data was collected from Traffic.com in the form of sensor data for three hours on 7/12/2008, from 3:00 to 6:00 P.M. This volume data, when input to AIMSUN was instrumental in creating a 185 X 185 origin-destination (O-D) matrix for this three-hour duration. A sub-area O-D matrix (185 X 185) is generated for the network under consideration from SEMCOG'S large regional matrix for the year 2015. The two 185 X 185 O-D matrices developed using two different tools from two different sources are input back to AIMSUN and are subjected to dynamic traffic assignment (DTA), while adjusting the DTA parameters.

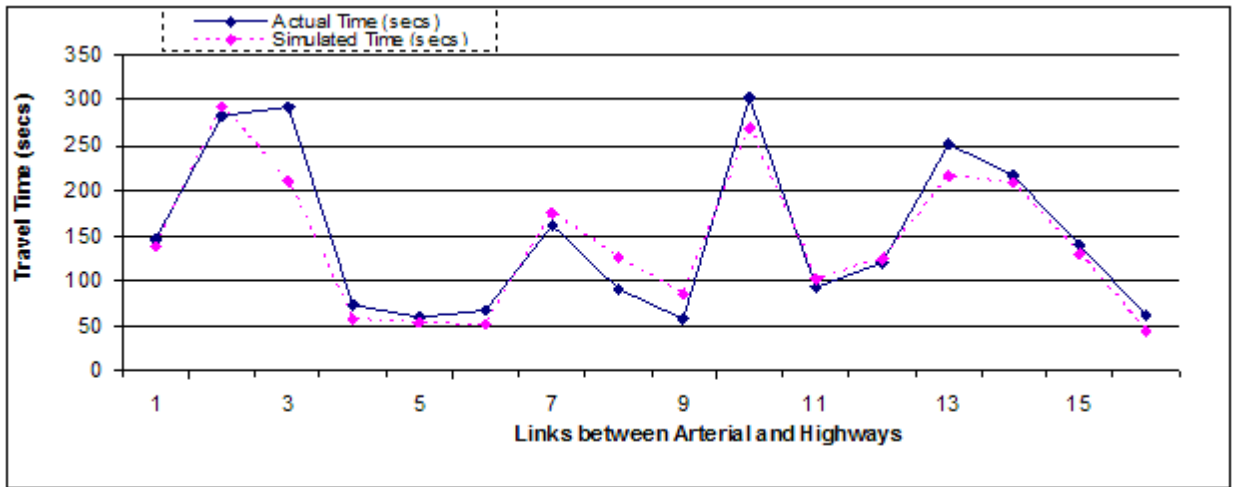
Sensors present in the model are used to record traffic volumes at five-minute intervals. These traffic volumes are compared to achieve a reasonable correspondence. DTA parameters are adjusted until a desired degree of correspondence is achieved between the two data sources.

Figures 9, 10, 11 and 12 show typical graphs used to determine calibration. Tables 4 and 5 show the statistical results. These graphs and tables show a close enough correspondence between simulation results and collected data to verify calibration.



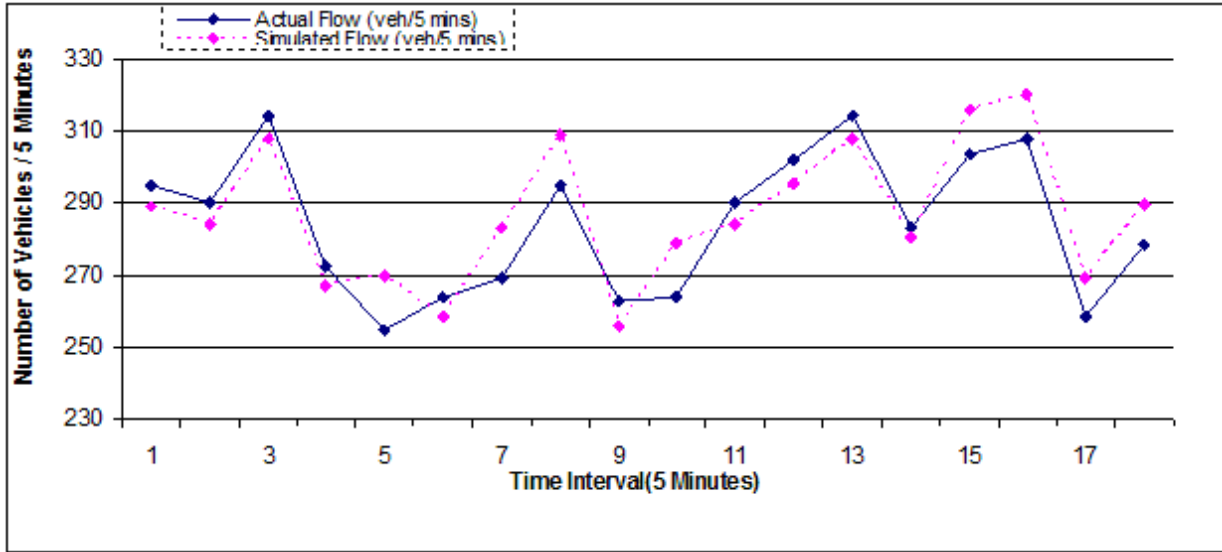
**Figure 9. No Incident Scenario**

Sensor: MI075200N (I-75 South of 12 Mile Road), Date: 7/12/2008, Time: 3:00 - 6:00 P.M.

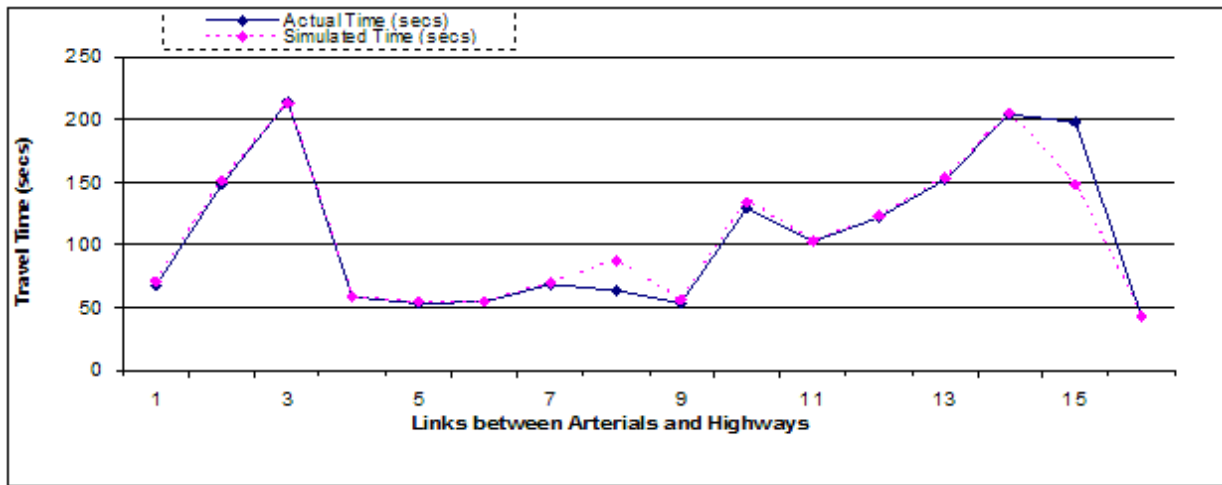


**Figure 10. No Incident Scenario**

Date: 7/12/2008, Time: 3:00 - 4:00 P.M.



**Figure 11. Incident Scenario: Abandoned Vehicle  
 Right-Lane Closure: SB I-75 @ 12 Mile Road  
 Sensor: MI075180S (I-75 South of 14 Mile Road), Date: 1/19/2009, Time: 8:35 - 10:00 A.M.**



**Figure 12. Incident Scenario: Abandoned Vehicle  
 Right-Lane Closure: SB I-75 @ 12 Mile Road**

**Table 4. Summary of Calibration Test Results – Traffic Volume**

WITH/WITHOUT INCIDENT	TYPES OF INCIDENTS	DATE, TIME OF THE INCIDENT	LOCATION OF THE INCIDENT	LOCATION OF THE SENSOR	FIGURE	ROOT MEAN SQUARE ERROR (RMSE) % ERROR	CORRELATION COEFFICIENT (R)	THEIL'S WEIGHT OF LARGE ERRORS (L)	THEIL'S VARIANCE PROPORTION (U/S)	THEIL'S COVARIANCE PROPORTION (C)	THEIL'S BIAS PROPORTION (B)
No Incident	No incidents	7/12/2008, 3PM-6PM	No Incident	S of 12 Mile at I-75	1A	0.03	0.85	0.01	0.12	0.89	0.12
				S of 14 Mile at I-75	1B	0.07	0.95	0.03	0.05	0.96	0.10
				S of 12 Mile at I-75	1C	0.03	0.86	0.02	0.29	0.84	0.02
		9/22/2008, 3PM-6PM	No Incident	S of 12 Mile at I-75	2A	0.02	0.95	0.01	0.03	0.98	0.12
				S of 14 Mile at I-75	2B	0.02	0.86	0.01	0.23	0.87	0.04
				S of 14 Mile at I-75	2C	0.03	0.95	0.01	0.26	0.86	0.02
With Incident	Abandoned Vehicles	1/19/2009, 8:35AM-10:00AM	SB-I-75 @ 12 Mile (Right Lane)	North of I-695 at I-75	4A	0.03	0.92	0.02	0.01	0.97	0.14
				S of 14 Mile at I-75	4B	0.04	0.88	0.02	0.00	0.98	0.07
	Flat Tire	1/19/2009, 5:40PM-7:05PM	SB-I-75 @ 12 Mile (Right Lane)	S of 12 Mile at I-75	4C	0.03	0.97	0.02	0.12	0.80	0.13
				S of 14 Mile at I-75	4D	0.03	0.96	0.02	0.06	0.81	0.18
	No Gas	1/24/2009, 3:15PM-4:40PM	NB-I-75 @ 13 Mile (Right Lane)	S of 14 Mile at I-75	4E	0.03	0.90	0.01	0.14	0.90	0.04
				S of 12 Mile at I-75	4F	0.02	0.92	0.01	0.20	0.86	0.01
	Mechanical Problems	1/26/2009, 2:25PM-3:50PM	SB-I-75 @ 12 Mile (Right Lane)	S of 12 Mile at I-75	4G	0.03	0.95	0.01	0.11	0.89	0.09
				S of 14 Mile at I-75	4H	0.03	0.97	0.01	0.15	0.89	0.03
	Debris on Road	2/6/2009, 4:25PM-5:50PM	SB-I-75 @ 14 Mile (Right Lane)	S of 14 Mile at I-75	4I	0.02	0.91	0.01	0.02	0.98	0.11
				S of 15 Mile at I-75	4J	0.02	0.96	0.01	0.10	0.95	0.01
	Accident	1/13/2009, 8:10AM-9:35AM	SB-I-75 @ 13 Mile (Right Lane)	S of 12 Mile at I-75	4K	0.03	0.93	0.01	0.02	0.86	0.34
				S of 14 Mile at I-75	4L	0.03	0.96	0.01	0.02	0.90	0.26

**Table 5. Summary of Calibration Test Results – Travel Time**

WITH/WITHOUT INCIDENT	TYPES OF INCIDENTS	DATE, TIME OF THE INCIDENT	LOCATION OF THE INCIDENT	FIGURE	ROOT MEAN SQUARE ERROR (RMSE) % ERROR	CORRELATION COEFFICIENT (R)	THEIL'S WEIGHT OF LARGE ERRORS (L)	THEIL'S VARIANCE PROPORTION (U/S)	THEIL'S COVARIANCE PROPORTION (C)	THEIL'S BIAS PROPORTION (B)
No Incident	No incidents	7/12/2008, 3PM-4PM	No Incident	3A	0.21	0.96	0.08	0.16	0.82	0.09
		9/22/2008, 3PM-4PM	No Incident	3B	0.15	0.97	0.07	0.10	0.80	0.15
With Incident	Abandoned Vehicles	1/19/2009, 8:35AM-10:00AM	SB-I-75 @ 12 Mile (Right Lane)	5A	0.12	0.97	0.06	0.13	0.94	0.00
				5B	0.06	0.99	0.04	0.19	0.85	0.03
	Flat Tire	1/19/2009, 5:40PM-7:05PM	SB-I-75 @ 12 Mile (Right Lane)	5C	0.11	0.98	0.04	0.03	0.89	0.14
				5D	0.07	0.98	0.05	0.04	0.94	0.07
	No Gas	1/24/2009, 3:15PM-4:40PM	NB-I-75 @ 13 Mile (Right Lane)	5E	0.18	0.96	0.07	0.01	0.87	0.17
				5F	0.06	0.99	0.02	0.00	0.98	0.08
Mechanical Problems	1/26/2009, 2:25PM-3:50PM	SB-I-75 @ 12 Mile (Right Lane)	5F	0.06	0.99	0.02	0.00	0.98	0.08	
			5F	0.06	0.99	0.02	0.00	0.98	0.08	

The model, calibrated along with the appropriate parameters, was used to test the effectiveness of alternative IMS on the same network. The two types of IMS were adapted from AIMSUN, then tested, lane closure, and forced turning (FT). Lane closure refers to a scenario where single or multiple lanes are closed for a given freeway section. FT refers to scenarios where vehicles are forced to divert from their original intended path, due to the occurrence of a road closure. For each IMS tested, two types of performance data are gathered, unit travel time and unit delay, both measured in seconds per kilometer per vehicle. In all the cases recorded, both travel time and delay measures are reduced under guided conditions signifying a positive impact of the IMS in alleviating congestion.

## **8. Conclusions**

### ***8.1. Statistical Analysis***

MLM can be used to predict traffic speed up to 30 minutes in the future. Only two speed values are required to make such predictions, making computations fast and data storage requirements minimal.

### ***8.2. Re-Routing Models***

Dynamic re-routing models can be used with an ITS to route traffic around incidents in near real-time, including changing alternative routes in response to traffic flow. A hardware-based model solver may be needed to perform needed computations in near-real time.

### ***8.3. Micro-Simulation for Incident Management Assessment Strategies***

Micro simulation analysis shows that managed routing of traffic improves traffic volume and travel time in dealing with a traffic incident.

## **9. Recommendations for Future Research**

### ***9.1. Statistical Analysis***

Additional validation of the MLM model can be obtained by re-estimating the parameters using data from a later 12-month period.

In addition, the MITSC data can be used to indicate the potential benefits of avoiding turbulent conditions such as those caused by non-metered entry during rush hour.

### ***9.2. Re-Routing Models***

For the re-routing model of the I-75 corridor, a formal comparison of the computational speed of the hardware and software solvers would be helpful.

A test of the re-routing model with respect to re-routing traffic around a freeway incident at MITSC is a necessary next step. This would involve obtaining the data needed by the model in near-real time and transmitting re-routing information via message signs or other electronic means to vehicles. Performance metrics would need to be developed.

### ***9.3. Micro-Simulation for Incident Management Assessment Strategies***

The role of traffic simulation in regional modeling should be explored.

## **10. Recommendations for Implementation**

### ***10.1. Statistical Analysis***

MLM models can be straightforwardly developed from traffic data on speed. Speed prediction from MLM models can be used in software to compute the freeway travel time from one location to another. Such times are often displayed on message signs.

### ***10.2. Re-Routing Models***

Implementation would depend on the results of the test of the model at the MITSC described in the preceding section.

### ***10.3. Micro-Simulation for Incident Management Assessment Strategies***

Traffic routing policies should be assessed using micro-simulation before implementation.

## **11. List of Acronyms, Abbreviations, and Symbols**

ADC	Analog-to-Digital Converter
CEE	Civil and Environmental Engineering
DTA	Dynamic Traffic Assignment
FT	Forced Turning
GVSU	Grand Valley State University
IMS	Incident Management Scenario
ITS	Intelligent Transportation Systems
MDOT	Michigan Department of Transportation
ME	Median Error
MIOH-UTC	Michigan Ohio University Transportation Center
MITSC	Michigan Intelligent Transportation Systems Center
MLM	Multi-Level Model
O-D	Origin Destination Matrix
SEMCOG	Southeastern Michigan Council of Governments
SOE	School of Engineering
USDOT	United States Department of Transportation
WSU	Wayne State University



## 12. Bibliography

Even, A. 2007. Multi-Commodity Dynamic Vehicle Routing Subject to Capacity Constraints With Real Time Transportation Information. Unpublished Masters Project. School of Engineering, Padnos College of Engineering and Computing, Grand Valley State University.

Even, A., S. Choudhuri, and C. Standridge. 2007. Dynamic Traffic Rerouting with Feedback from Infrastructure, INFORMS Annual Meeting, Seattle.

Georgescu, L. 2009. Applied Analysis Of Urban Interstate Highway Traffic Data. Unpublished Masters Thesis. School of Engineering, Padnos College of Engineering and Computing, Grand Valley State University.

Khasnabis, S., S. Mishra, S. Swaim, E. A. Elibe, and S. Vuyyuru. 2010. Management and Analysis of Michigan Intelligent Transportation System Center Data with Application to the Detroit Area I-75 Corridor. Working Paper. Department of Civil and Environmental Engineering, Wayne State University. Detroit, MI.

Mishra, S., and S. Khasnabis. 2007. Survey of Literature Review: Congestion Relief by Travel Time Minimization in Near Real Time. Working Paper. Department of Civil and Environmental Engineering, Wayne State University. Detroit, MI.

Mishra, S., S.Khasnabis., S.K.Swain., and A.Manori. 2009. A Framework for Evaluating Incident Management Strategies on Freeways. 2<sup>nd</sup> International Symposium for Freeway and Tollway Operations (ISFO), Honolulu, Hawaii.

Rahman, A., S. Choudhuri, and C. Standridge. 2008. A Real-Time Hardware-Based Solver for the Large-Scale Traffic Rerouting Problem Using ITS Data. INFORMS Annual Meeting, Washington, DC.

Rahman, A. 2009. Unpublished Masters Thesis. School of Engineering, Padnos College of Engineering and Computing, Grand Valley State University.

Standridge, Charles, J. Gallivan, and S. Choudhuri. 2009. Simulation Software Interoperability, Simulation Environments, and Extensions. Proceedings of the 2009 Industrial Engineering Research Conference.

Yada, V., S. Choudhuri, and C. Standridge. 2007. Web-Based Data Repository for Collaboration among ITS Researchers. INFORMS Annual Meeting, Seattle.